



Cassette awning

markilux 970

Aesthetics and technology perfectly married – the compact cassette awning in a timeless, purist design.



Product characteristics

Wind resistance class 2

Beaufort 5 → 7.5–10.4 m/s → 28–37 km/h → 17–23 mph



01
02
03
04
05
06
07
08
09
10
11
12
13
14
15
16
17

1 face fixture



1 face fixture, maximum pitch of 30°



1 top fixture



1 top fixture, view from the rear and below

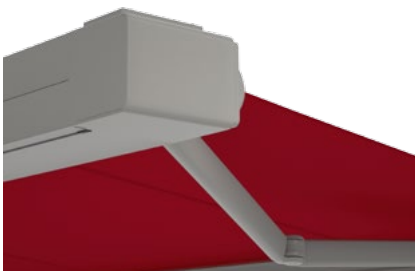

2 drop valance 1)



2 drop valance 1), during extension

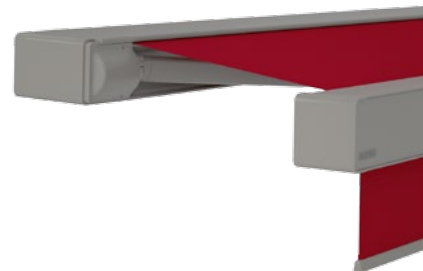

3 LED spotlights underneath the cassette 1)



4 bionic tendon made of high-tech fibres for optimum power transference



5 arm bearer with tilt device technology, integrated windlock mechanism



1) optional configuration

Product characteristics

Description

- angular cassette awning built in an unobtrusive style, with ingenious accessory option and unique fixture technology.

Special features

- option of a drop valance up to a projection of 300 cm – vertical protection against low-lying sun, wind and inquisitive glances integrated into the front profile, can be operated manually or by motor
- option of directional LED spotlights fitted to the underside of the cassette – provide an appealing atmosphere in the evening
- various front panel colours can be combined with the standard awning frame colours
- the special cassette profile surrounds the roller tube even when the awning is extended and lends the awning a harmonious, closed appearance
- the straight lines with smooth front panel suit a minimalistic building style perfectly
- the design characteristics allow the awning to be fitted into niches and reveals
- the virtually invisible face and top fixture brackets mean the awning cassette fits flat against the building
- the tilt device technology with integrated windlock mechanism functioning as arm bearers ensures the awning closes cleanly regardless of the pre-set pitch

Dimensions

- cassette in the standard version: depth 266 mm, height 140 mm
- single unit: minimum width 250 cm at the smallest projection of 150 cm maximum width 500 cm at the largest projection of 350 cm or 600 cm at a maximum projection of 300 cm

Roller tube and lateral bearings

- round roller tube Ø 85 mm with keyway, galvanised steel – excellent stability ensures near perfect cover performance even at the largest widths
- the cassette side cap is made of die-cast aluminium, powder coated

Awning profiles

- extruded aluminium, in façade quality, powder coated
- two-piece cassette with integrated brush seal – providing the awning cover with optimum protection against the elements
- angular front profile with integrated rain gutter and a smooth front panel
- the front panel is also available in anodised aluminium E6/EV1

Folding arms

- profiles in extruded aluminium, in façade quality, powder coated
- moving parts made of drop-forged aluminium – the arms are therefore extremely fracture resistant
- pivot bolts in stainless steel run in Teflon-coated bronze bushes – practically maintenance free, virtually silent and extremely hard-wearing
- power transference via the innovative bionic tendon at the elbow joint, made of high tensile, hightech fibres – low in friction, noiseless, insensitive to corrosion and UV resistant

Side caps

- the cassette end caps are made of high-quality plastic, powder coated
- the internal caps to cover the internal arm bearers at the side are made of die-cast aluminium
- the front profile end caps are made of die-cast aluminium, powder coated, with water drainage holes

Fixture brackets

- face fixture, top fixture, eaves fixture
- extruded aluminium, powder coated
- awning pitch adjustment range 5°–30°
- spacer plates, stand-off brackets and other accessories are available

01 **Frame and front panel colours**

02 markilux frame colours without surcharge

03 traffic white RAL 9016

metallic aluminium RAL 9006

grey brown, similar to RAL 8019



06 off-white textured finish, 5233 ¹⁾

stone grey metallic, 5215 ¹⁾

anthracite metallic, 5204 ¹⁾

08



09 Havana brown textured finish, 5229 ¹⁾

Non-standard powder-coated finish

Bespoke frame colours at a surcharge – matt, metallic and pearl finishes as well as other colour ranges (DB, Tiger etc.) on request. All frame colours are available at a surcharge with enhanced corrosion protection.



Colours may differ slightly from those depicted in both hue and finish.

¹⁾ textured finish

16 **Combination Possibilities**

17 All standard or ambient front panel colours can be freely combined with the standard frame colours.



Additional front panel colours

Depicted in combination with the frame colour traffic white, RAL 9016,. The additional front panel colours can be freely combined with all frame colours.

anodised aluminium E6/EV1



sulphur yellow RAL 1016



traffic red RAL 3020



pitch black RAL 9005



yellow green RAL 6018



traffic purple RAL 4006



01

02

03

04

05

06

07

08

09

10

11

12

13

14

15



16

17

Colours may differ slightly from those depicted in both hue and finish.

Dimensions and configuration options

Single unit

Order dimensions	Overall awning width								Minimum width	
	250	300	350	400	450	500	550	600	Motor	Crank handle
	195 250	251 300	301 350	351 400	401 450	451 500	501 550	551 600		
H	150	1)							195	195
	200	1)							245	245
	250	—	1)						295	295
	300	—	—	1)			2)	2)	345	345
	350	—	—	—	1) 2)	2)	2)	—	395	395

1) = please note the minimum widths!

2) = drop valance not available

H = drop

 = 2 folding-arms,
2 brackets

 = 2 standard arms

dimensions in cm

Operation

	standard	optional
crank handle	✓	—
spring-assisted crank handle	—	✓
hard-wired motor	—	✓
silentec motor (optionally with an external io / RTS receiver) ¹⁾	—	—
radio-controlled motor io, 868 MHz	—	✓
radio-controlled motor RTS, 433 MHz	—	✓
radio-controlled motor RTS, 433 MHz with manual override ¹⁾	—	—

1) for awnings with a maximum of 2 arms

Coupled Awning

not available

Awning cover

	fabric range no.	standard	optional
sunvas	301.. / 309..–315..	✓	—
perla	370..	—	✓
sunsilk	324.. / 325.. / 328.. / 369..	✓	—
perla FR	374.. / 375..	—	✓
perfotex	331.. / 332..	—	—
transolair	338..	—	—
vuscreen Alu	317..	—	—
Soltis Perform 92	92-20..	—	—
glass fibre screen	272..	—	—
valance, 20 cm		—	✓ ¹⁾

1) only for drop valance

Shadeplus / drop valance

	standard	optional
height 170 cm		
maximum awning projection 300 cm ¹⁾		
crank handle	✓	—
hard-wired motor	—	✓
radio-controlled motor io, 868 MHz	—	✓
radio-controlled motor RTS, 433 MHz	—	✓
cover	sunvas / sunsilk / transolair / vuscreen Alu	

1) folding arms in a taller version (with cable conduits);
not available in the dimensions 501 cm – 600 cm × 300 cm

Optional accessories

drop valance, manual or motor operation
LED spotlights underneath the cassette
infrared heater 2000 W / 2500 W
infrared heater 2500 W with integrated radio-controlled receiver 868 MHz io
automatic controls (light, wind, rain)

N.B! – Important background information can be found in the chapter “Optional Accessories”.

Fixture brackets

face fixture bracket 100 mm L	72826.
face fixture bracket 100 mm R	72827.
spreader plate A 430 × 160 × 12 mm	72870.
spreader plate B 300 × 400 × 12 mm	75325.
spreader plate A 310 × 130 × 12 mm	72526.
stand-off bracket 80–300 mm	72872.
top fixture bracket 90 mm L	72860.
top fixture bracket 90 mm R	72861.
eaves fixture bracket 90 mm L, 150 mm plate	72874.
eaves fixture bracket 90 mm R, 150 mm plate	72875.
eaves fixture bracket 90 mm, 270 mm plate	71659.
flat plate and angled bracket for eaves fixture, machine finish aluminium, 500 mm plate	716620
spreader plate 260 × 60 × 12 mm for eaves fixture bracket 90 mm	75383.
angled profile for eaves fixture 100 × 100 × 12 mm, machine finish aluminium, undrilled, by the metre (max. 3 m)	79380.

Lighting options

Swivelling LED spotlights in solid aluminium housing



A radio receiver and a hand-held radio transmitter ensure convenient operation



Technical specification

operating voltage	230 V, 50 Hz
power output of an LED spotlight	5 W
bulbs	LED (12 V)
number of transformers	1 units
light temperature	2700 K
IP protection class	IP 44
service life	approx. 20,000 h

Control

	standard	optional
radio-controlled dimmer io 868 MHz	✓	—
radio-controlled dimmer RTS 433 MHz	✓	—

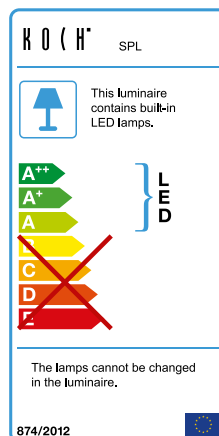

01
02
03
04
05
06
07
08
09
10
11
12
13
14
15
16
17

01 **Lighting options**

02 LED spotlights

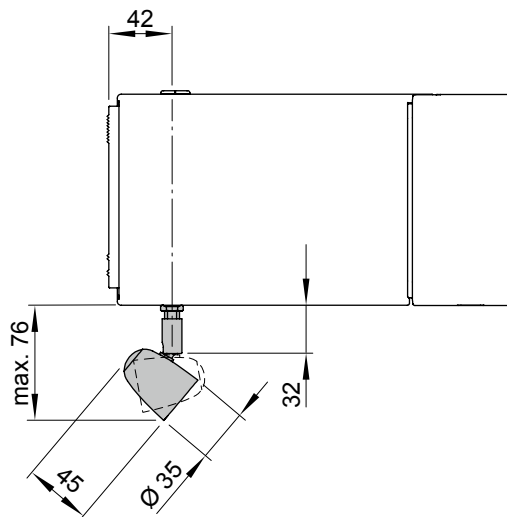

08

09 LED spotlight distribution in the front profile

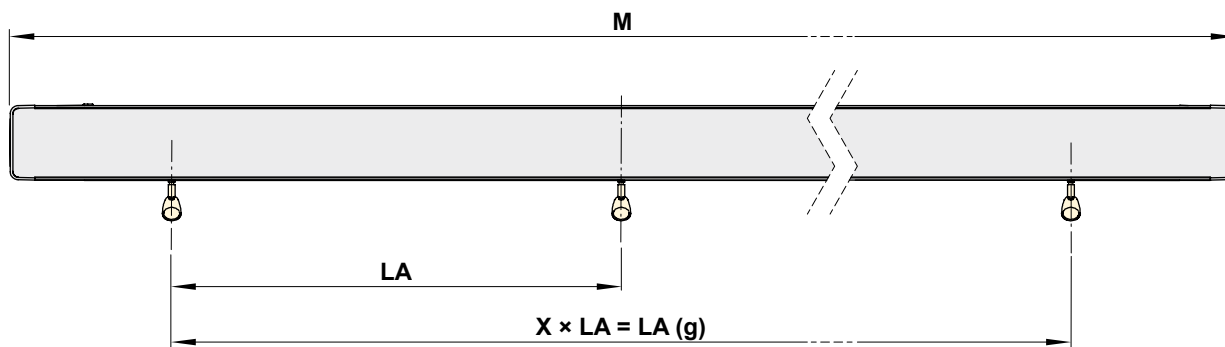

Overall awning width	No. of spotlights	LA	LA (g)
195-250	3	75	150
251-300	3	98	196
301-350	3	98	196
351-400	4	98	294
401-450	4	98	294
451-500	5	98	392
501-550	5	98	392
551-600	6	98	490

dimensions in cm

LA (g) = distance between the Spotlights (total)

M = order dimension = awning width

dimensions in mm

Bracket fixture range

Face fixture

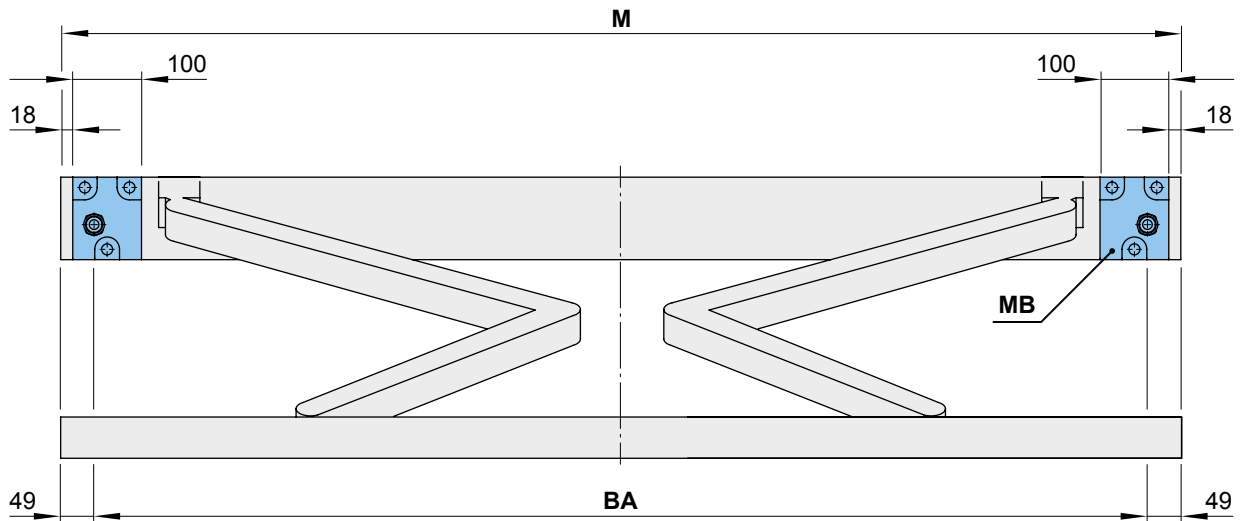

Top fixture

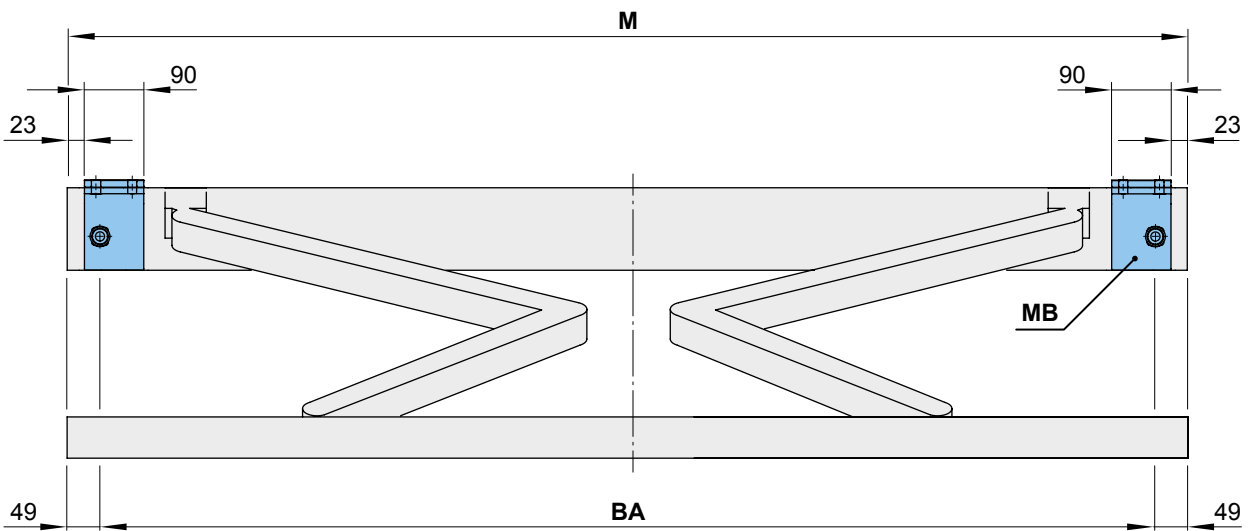

Eaves fixture

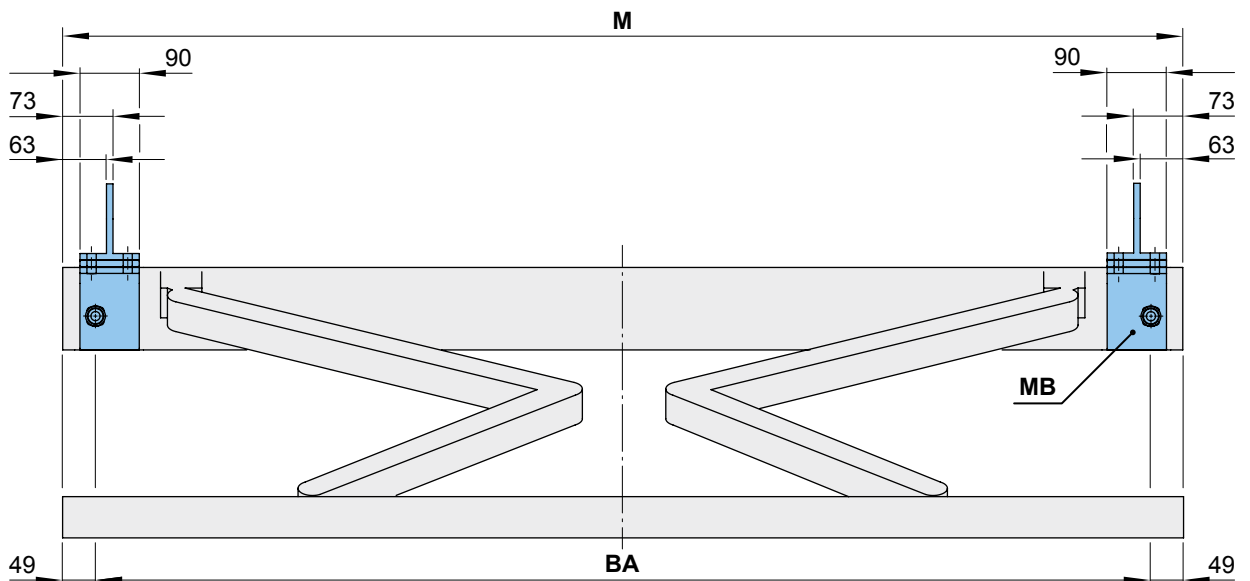

BA = width between fixture points

MB = bracket fixture range

M = *order dimension* = awning width

dimensions in mm

01
02
03
04
05
06
07
08
09
10
11
12
13
14
15
16
17

Bracket fixture range

		Overall awning width							
		250	300	350	400	450	500	550	600
Order dimensions		195	251	301	351	401	451	501	551
		250	300	350	400	450	500	550	600
		No of brackets No. of fixing points							
W	BHT	10 2 6							
BP		A 2 16		B 2 8		C 2 12			
DA / DE ¹⁾	9	2 8							

dimensions in cm

08

N.B.! If awnings are installed directly next to each other, a minimum distance of 50 mm must be maintained.

1) = for information on other mounting types, see chapter "Pull-out forces"

BHT = bracket width

BP = spreader plate A, B or C, to be positioned behind the folding arm

DA = eaves fixture bracket

DE = top fixture bracket

W = face fixture bracket

Face fixture

Fixtures, fittings and accessories

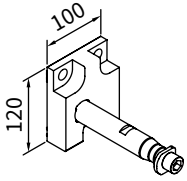

face fixture bracket
left

72826.

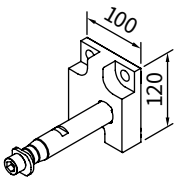

face fixture bracket
right

72827.

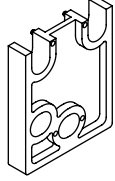

spacer plate for
face fixture

100 × 120 × 20 mm

Attention!
stack to a max. height of
200 mm

718581

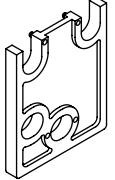

spacer plate for
face fixture

100 × 120 × 12 mm

718571

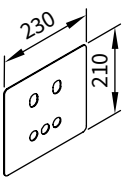

decorative plate
for spacer plates
and stand-off brackets
in the case of external
insulation

230 × 210 × 2 mm

71843.

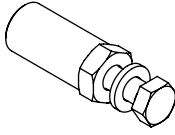

bolt reduction assembly
M 16 → M 12 / SW 27

50 mm

753891

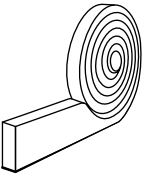

compression tape,
PU soft foam material
to eliminate gaps,
in rolls of 15 m, gap size
from 3 mm to 7 mm,
with a minimum resist-
ance to water ingres-
sion of 600 Pa, grey

795721

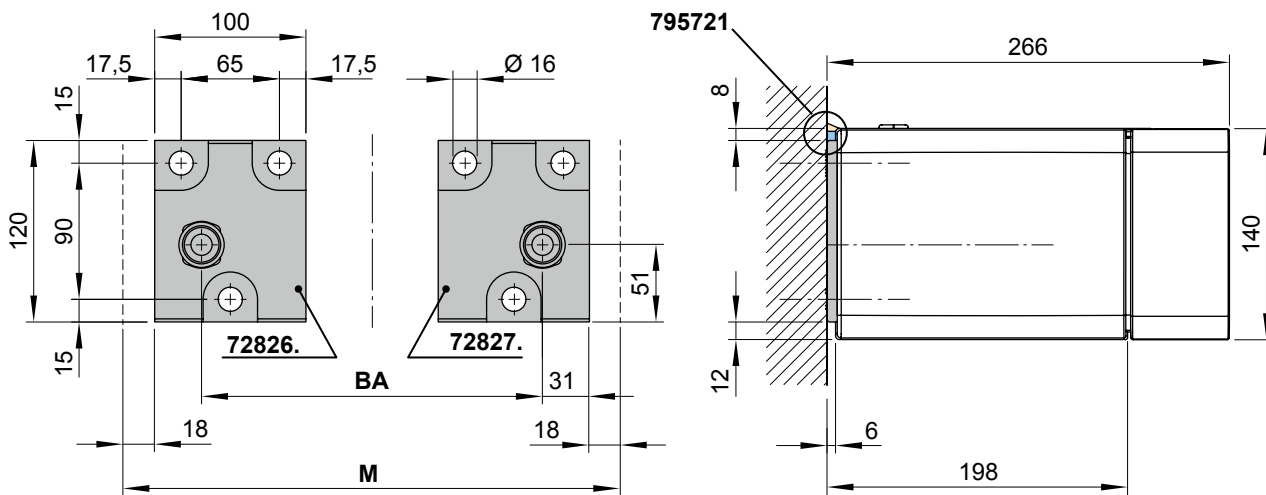

BA = width between fixture points

dimensions in mm

01
02
03
04
05
06
07
08
09
10
11
12
13
14
15
16
17

Face fixture with spreader plate A

Fixtures, fittings and accessories

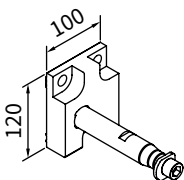

face fixture bracket
left

72826.

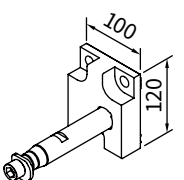

face fixture bracket
right

72827.

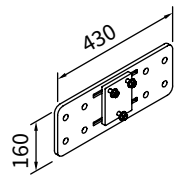

spreader plate A
430 × 160 × 12 mm

72870.

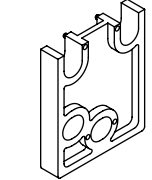

spacer plate for face fixture
100 × 120 × 20 mm

Attention!
stack to a max. height of 200 mm

718581

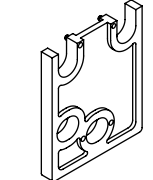

spacer plate for face fixture
100 × 120 × 12 mm

718571

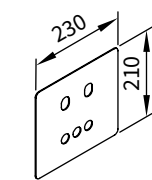

decorative plate for spacer plates and stand-off brackets in the case of external insulation
230 × 210 × 2 mm

71843.

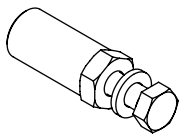

bolt reduction assembly
M 16 → M 12 / SW 27
50 mm

753891

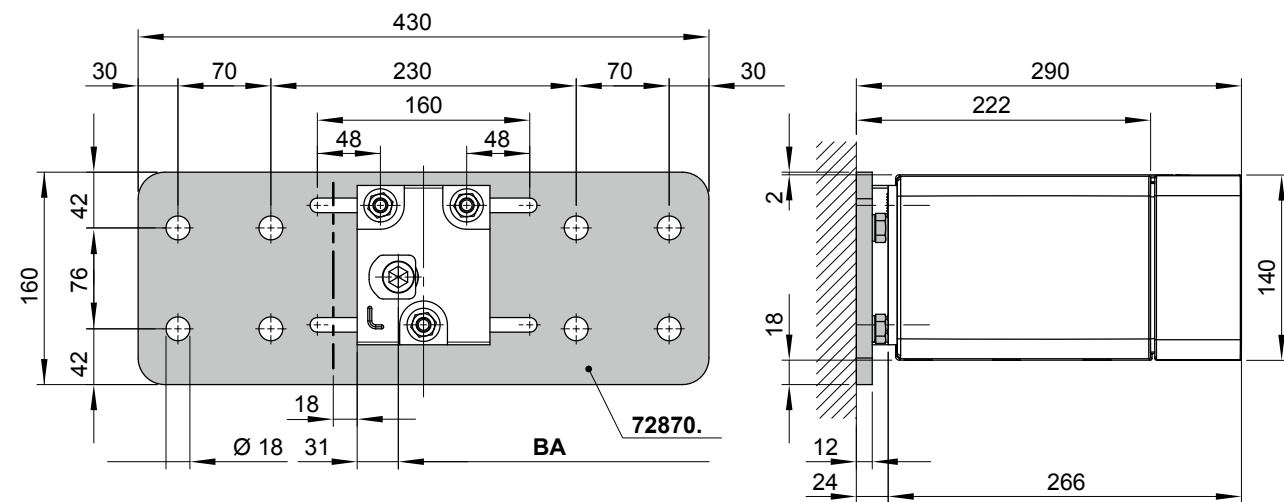

dimensions in mm

Face fixture with spreader plate B

Fixtures, fittings and accessories

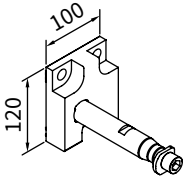

face fixture bracket
left

72826.

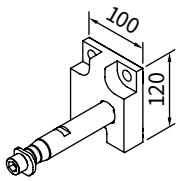

face fixture bracket
right

72827.

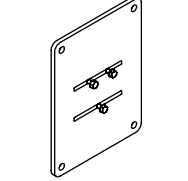

spreader plate B
300 × 400 × 12 mm

75325.

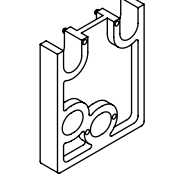

spacer plate for
face fixture
100 × 120 × 20 mm

Attention!
stack to a max. height of
200 mm

718581

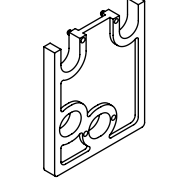

spacer plate for
face fixture
100 × 120 × 12 mm

718571

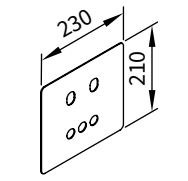

decorative plate
for spacer plates
and stand-off brackets
in the case of external
insulation
230 × 210 × 2 mm

71843.

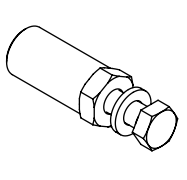

bolt reduction assembly
M 16 → M 12 / SW 27
50 mm

753891

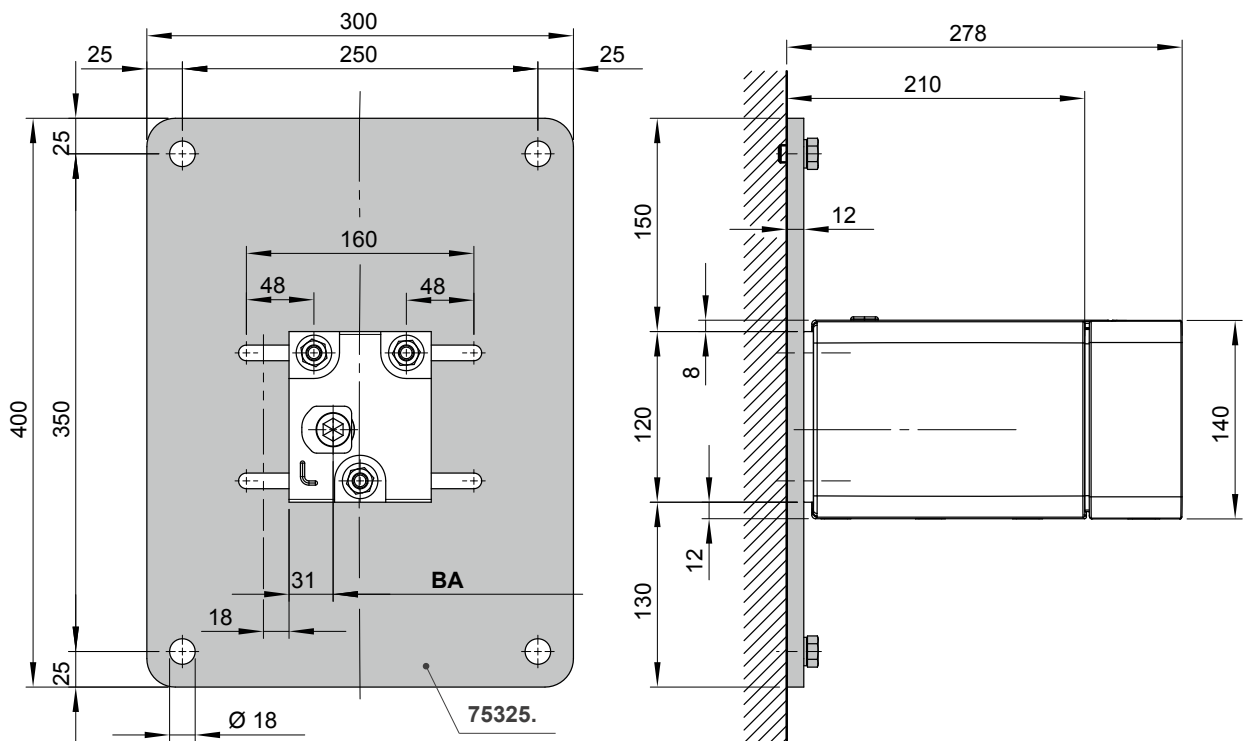

dimensions in mm

01
02
03
04
05
06
07
08
09
10
11
12
13
14
15
16
17

Face fixture with spreader plate C

Fixtures, fittings and accessories

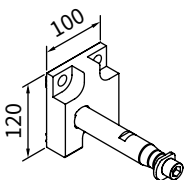

face fixture bracket
left

72826.

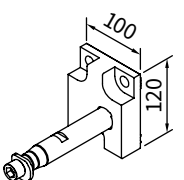

face fixture bracket
right

72827.

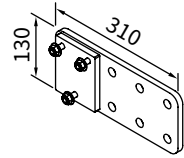

fixing plate C
310 × 130 × 12 mm

72526.

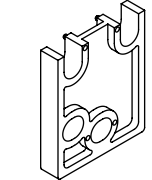

spacer plate for face fixture
100 × 120 × 20 mm

Attention!
stack to a max. height of 200 mm

718581

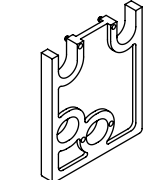

spacer plate for face fixture
100 × 120 × 12 mm

718571

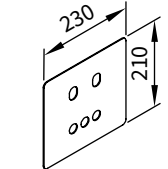

decorative plate for spacer plates and stand-off brackets in the case of external insulation
230 × 210 × 2 mm

71843.

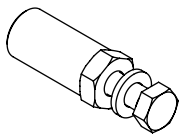

bolt reduction assembly
M 16 → M 12 / SW 27
50 mm

753891

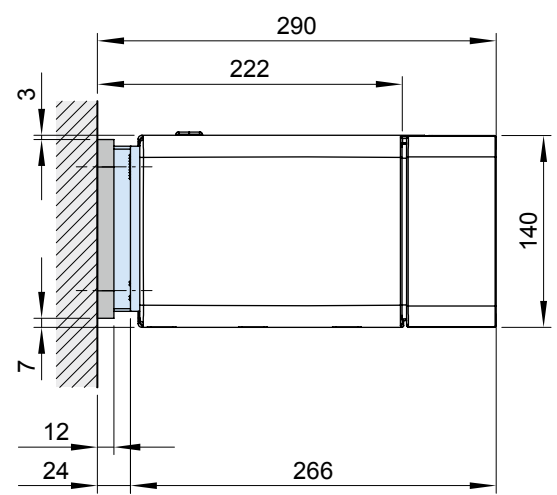
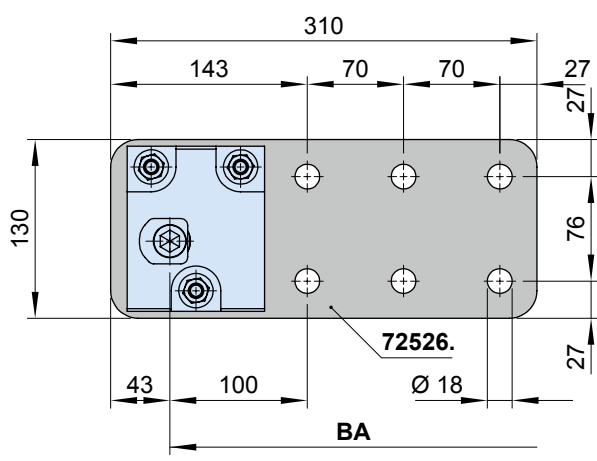

dimensions in mm

Face fixture with stand-off bracket

Fixtures, fittings and accessories

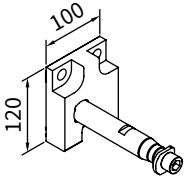

face fixture bracket
left

72826.

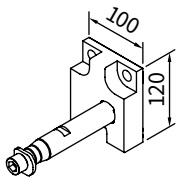

face fixture bracket
right

72827.

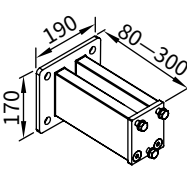

guide rod bracket
for face fixture bracket

please refer to "Face fixture with stand-off brackets"

72872.

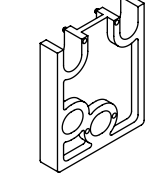

spacer plate for
face fixture

100 × 120 × 20 mm

Attention!
stack to a max. height of
200 mm

718581

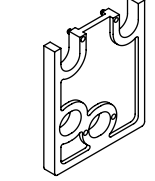

spacer plate for
face fixture

100 × 120 × 12 mm

718571

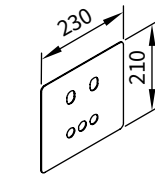

decorative plate
for spacer plates
and stand-off brackets
in the case of external
insulation

230 × 210 × 2 mm

71843.

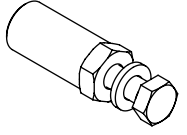

bolt reduction assembly
M 16 → M 12 / SW 27

50 mm

753891

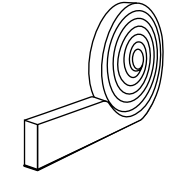

compression tape,
PU soft foam material
to eliminate gaps,
in rolls of 8 m, gap size
from 3 mm to 7 mm,
with a minimum resist-
ance to water ingress-
ion of 600 Pa, anthracite

795721

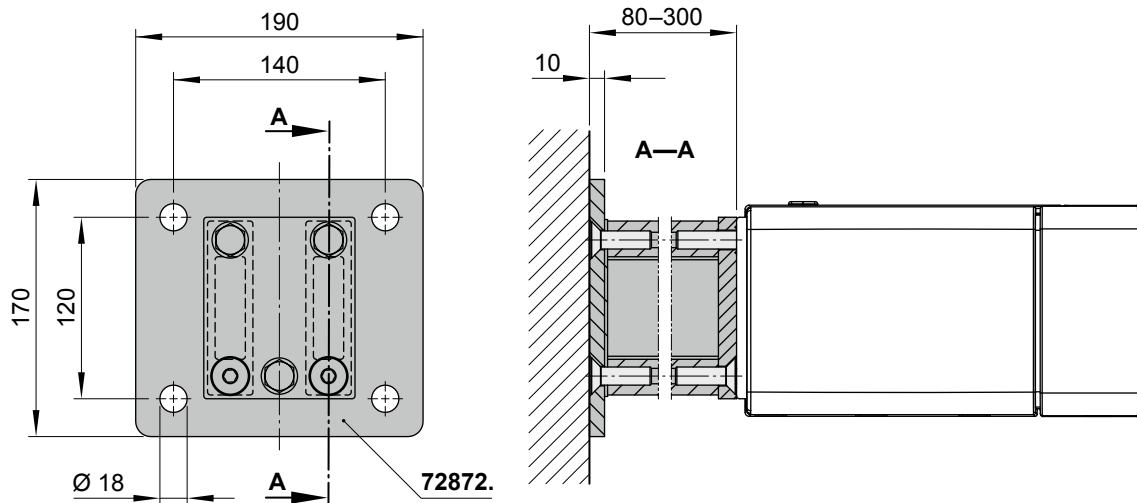

dimensions in mm

01
02
03
04
05
06
07
08
09
10
11
12
13
14
15
16
17

01 **Top fixture**

02 Fixtures, fittings and accessories

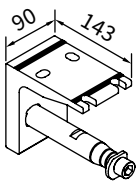

top fixture bracket
left

05 **72860.**

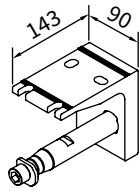

top fixture bracket
right

72861.

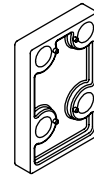

spacer plate for
top fixture

90 × 140 × 20 mm

Attention!
stack to a max. height of
200 mm

716311

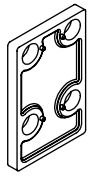

spacer plate for
top fixture

90 × 140 × 12 mm

716411

08

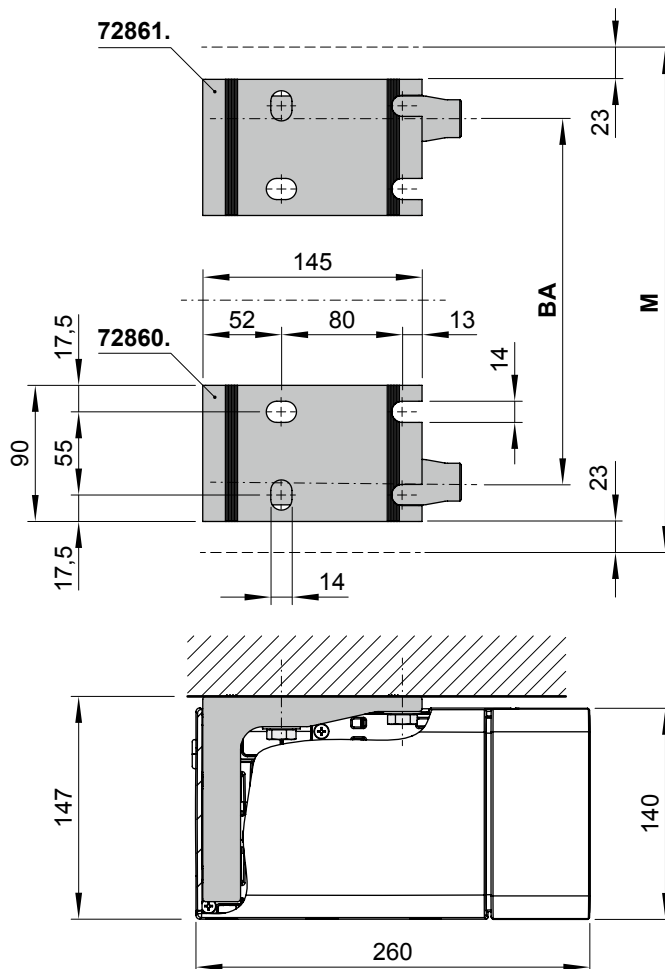

dimensions in mm

Eaves fixture

Fixtures, fittings and accessories

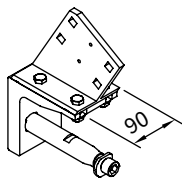

eaves fixture bracket
left

72874.

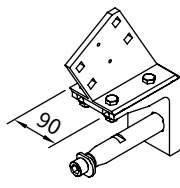

eaves fixture bracket
right

72875.

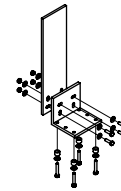

flat plate and angled
bracket for eaves fixture
machine finish

741290

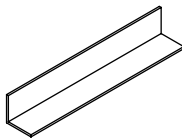

angled aluminium profile
100 × 100 × 10 mm
available by the metre
not pre-drilled
793800 machine finish

79380.

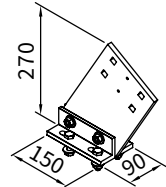

eaves fixture bracket
height of the top plate
270 mm

71659.

With eaves fixture bracket, 150 mm plate (71612.)

With eaves fixture bracket, 270 mm plate (71659.)

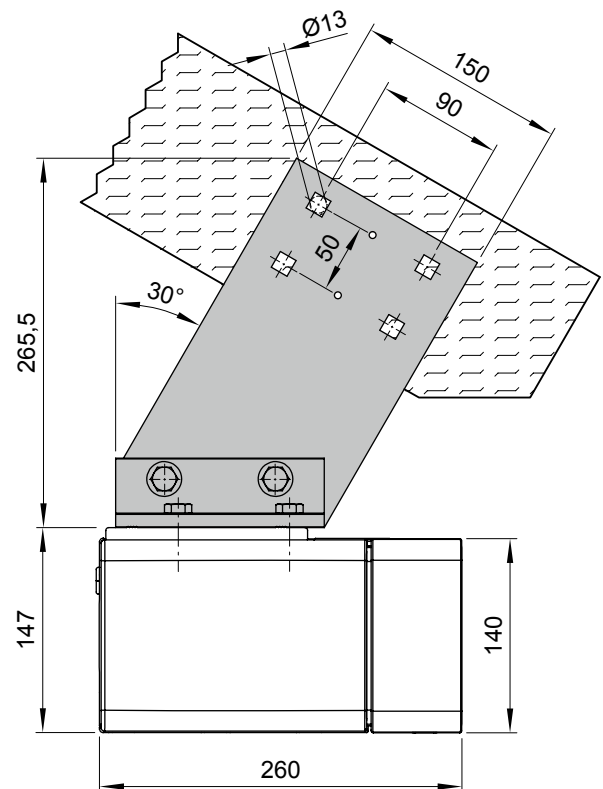
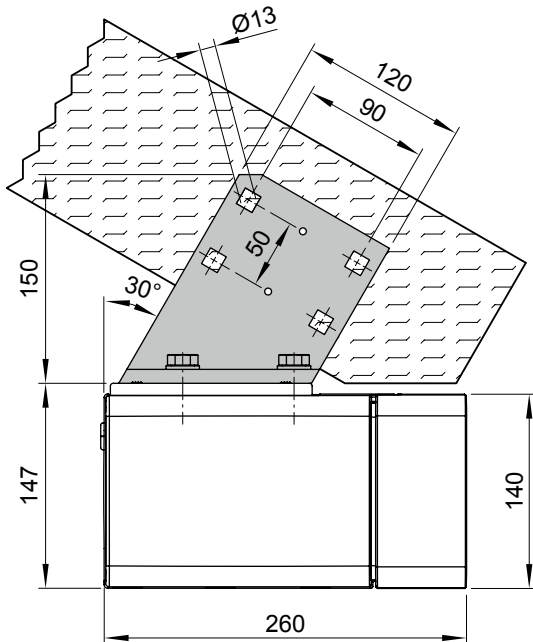

dimensions in mm

01
02
03
04
05
06
07
08
09
10
11
12
13
14
15
16
17

Eaves fixture with additional plate

Fixtures, fittings and accessories

eaves fixture bracket
left

72874.

eaves fixture bracket
right

72875.

supplementary flat plate
eaves fixture
260 × 60 × 12 mm

75383.

eaves fixture bracket
150 mm

71612.

eaves fixture bracket
height of the top plate
270 mm

71659.

flat plate and angled
bracket for eaves fixture
machine finish

741290

angled aluminium profile
100 × 100 × 10 mm
available by the metre
not pre-drilled
793800 machine finish

79380.

With eaves fixture bracket 150 mm (71612.)

With eaves fixture bracket 270 mm (71659.)

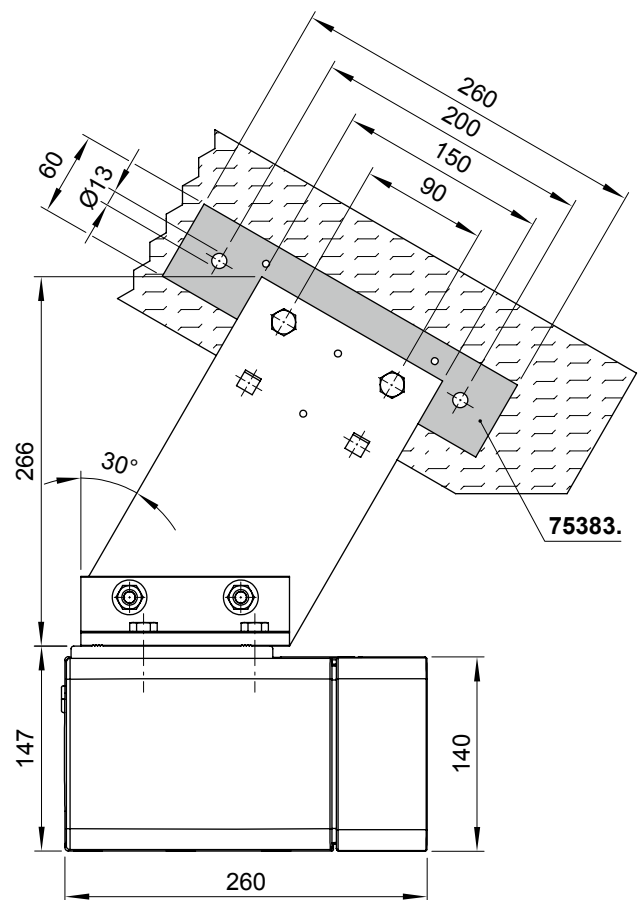
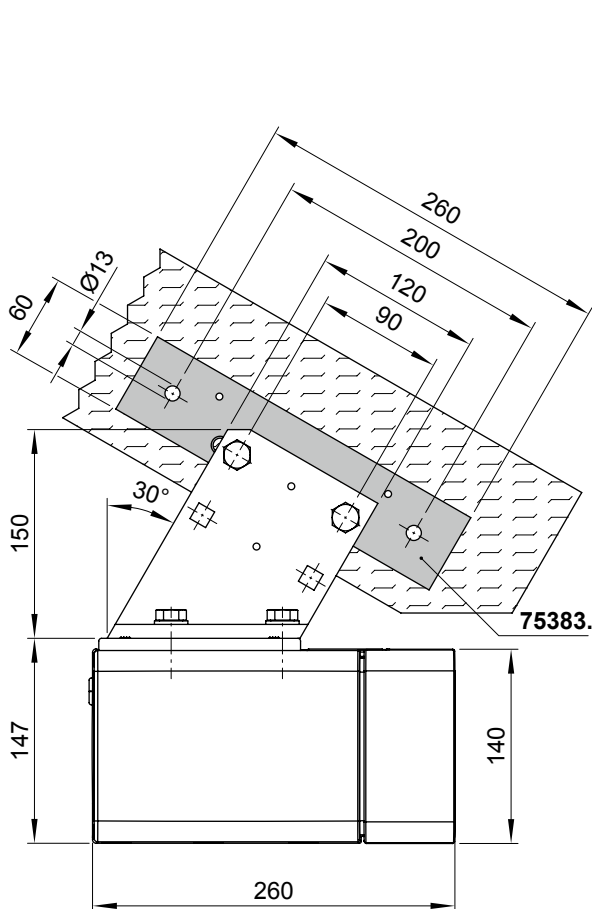

dimensions in mm

Awning with shadeplus

Face fixture

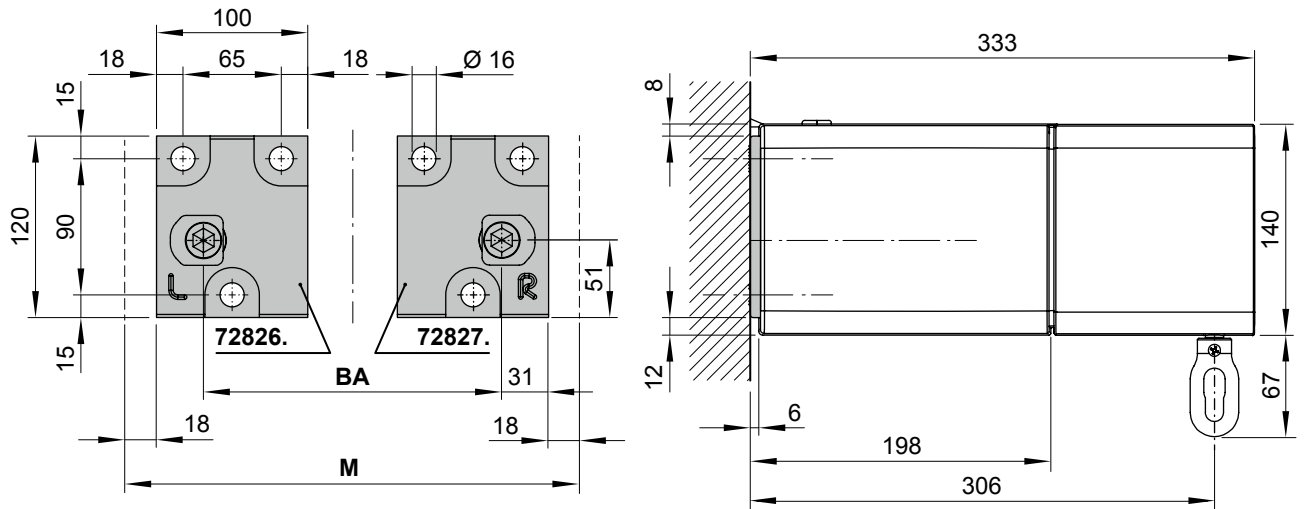

Top fixture

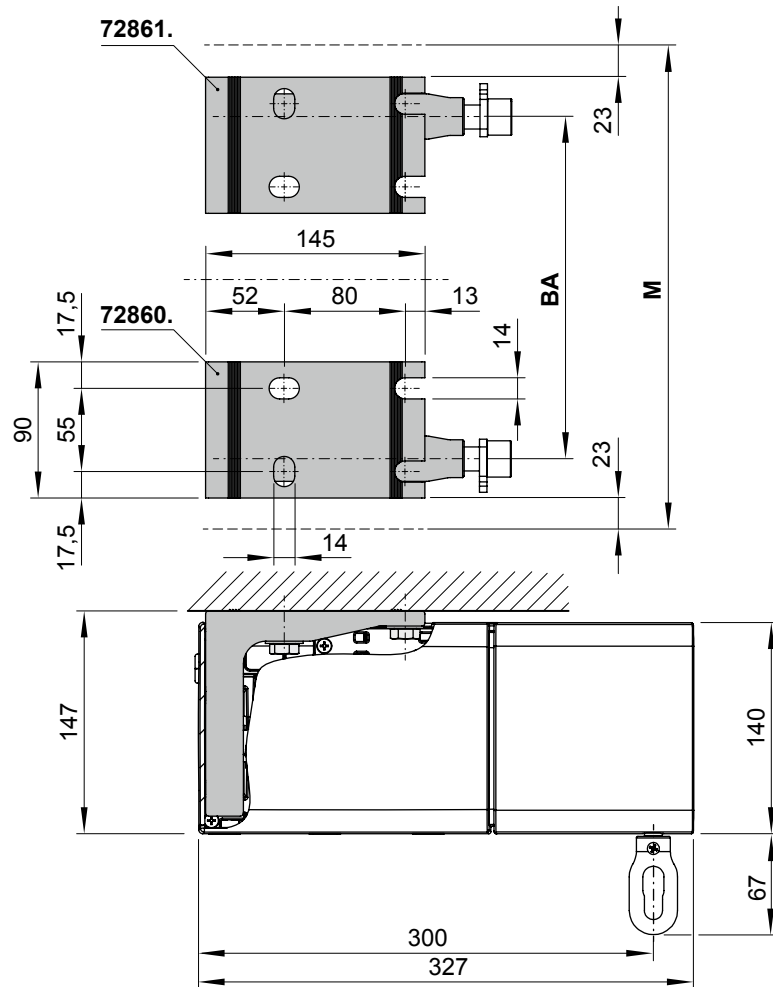

dimensions in mm

01
02
03
04
05
06
07
08
09
10
11
12
13
14
15
16
17

01 **Face fixture, manual operation**

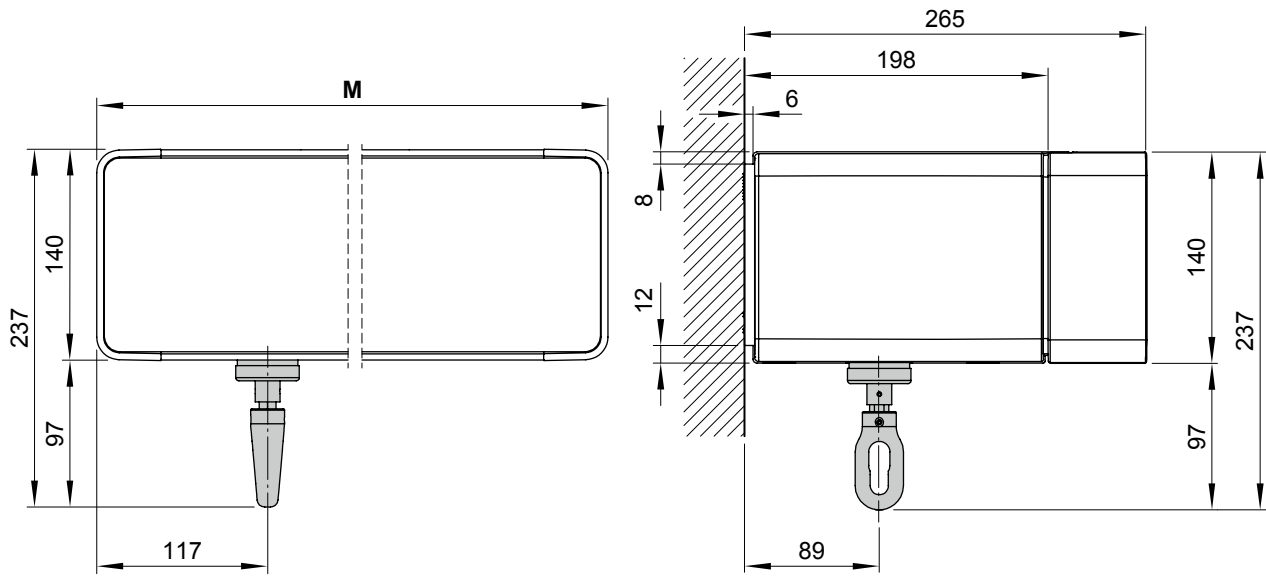

08

11 **Reveal fixture, motor drive**

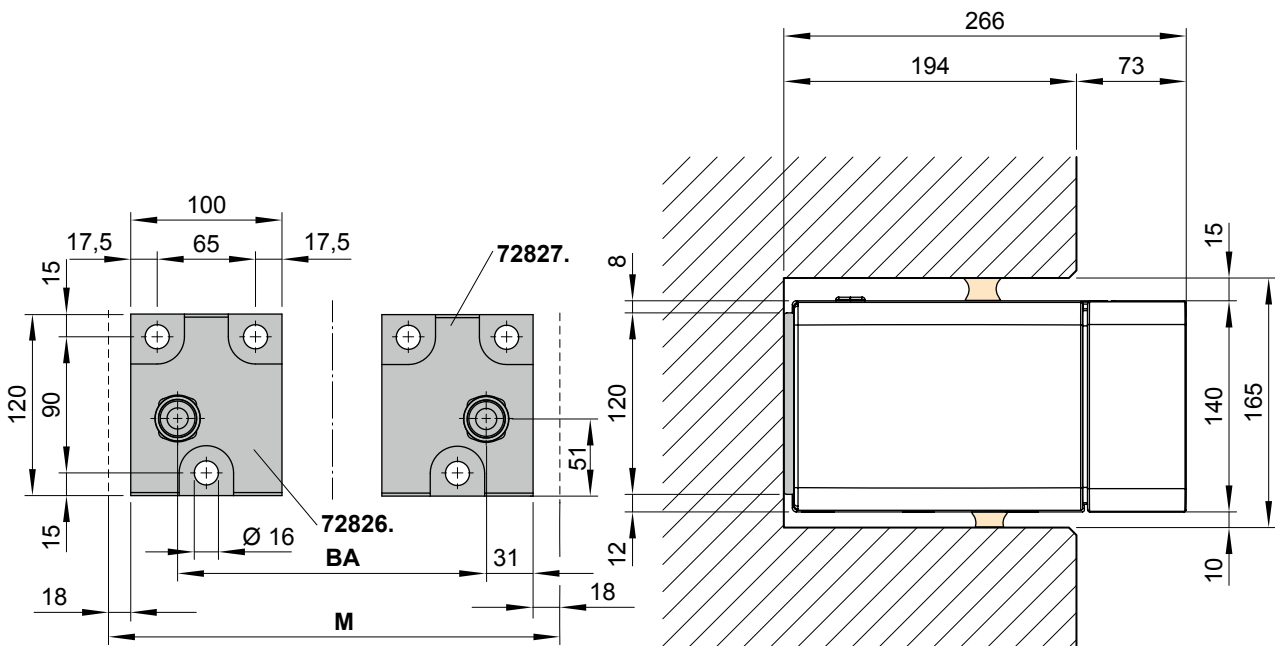

- 72826. = face fixture bracket left
- 72827. = face fixture bracket right
- BA = width between fixture points
- M = *order dimension* = awning width

dimensions in mm

Motor cable exit point

Face fixture

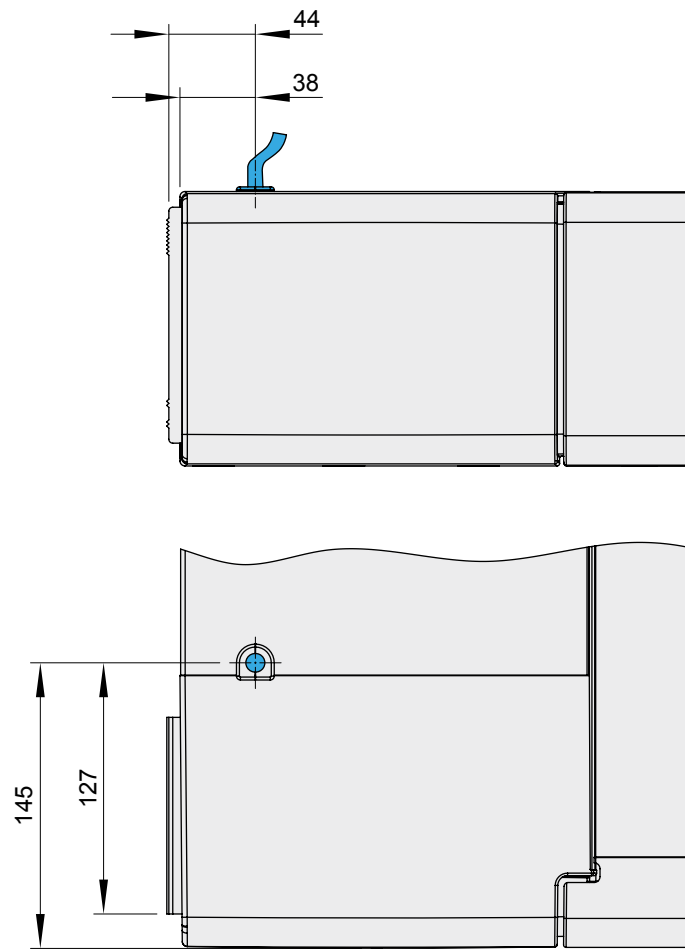

Top fixture

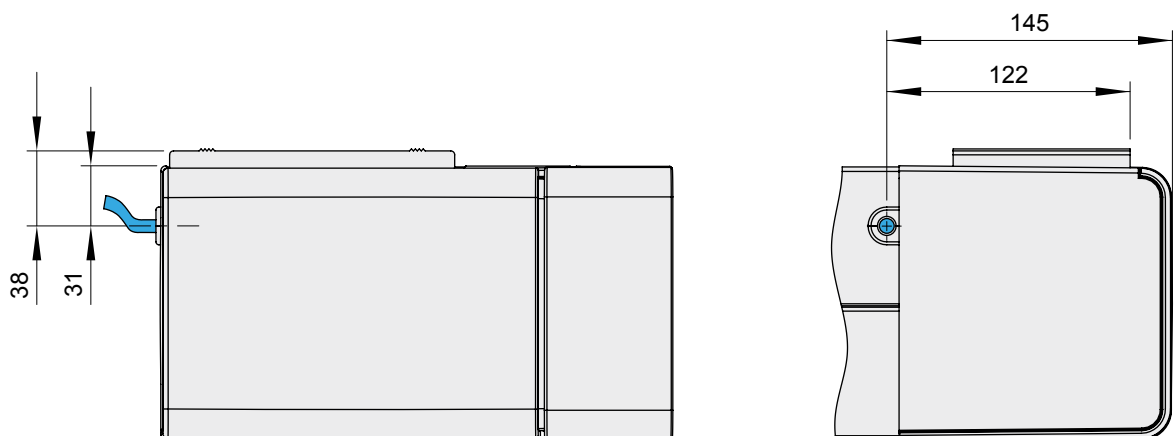

dimensions in mm

- 01
- 02
- 03
- 04
- 05
- 06
- 07
- 08**
- 09
- 10
- 11
- 12
- 13
- 14
- 15
- 16
- 17

01

02

03

04

05

06

07

08

09

10

11

12

13

14

15

16

17